

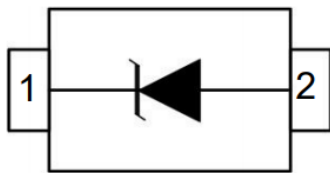

Pinout and Functional Block Diagram



Applications

- Series ATA
- USB2.0 Power and Data Line Protection
- Notebooks, Desktops, and Servers
- Cell Phone Handsets and Accessories
- Display Ports
- Digital Visual Interface (DVI)
- MDDI Ports

Description

The SD0505D52U1 is a low-capacitance Transient Voltage Suppressor (TVS) designed to provide electrostatic discharge (ESD) protection for high-speed data interfaces. With typical capacitance of 0.4 pF, SD0505D52U1 is designed to protect parasitic-sensitive systems against over-voltage and over-current transient events. It complies with IEC 61000-4-2 (ESD), Level 4 (± 15 kV air, ± 8 kV contact discharge), IEC 61000-4-4 (electrical fast transient - EFT) (40 A, 5 / 50 ns), very fast charged device model (CDM) ESD and cable discharge event (CDE), etc.

SD0505D52U1 uses ultra-small SOD-523 package. Each device can protect one high-speed data line. It offers system designers flexibility to protect single data line where space is a premium concern. The combined features of low capacitance, ultra-small size and high ESD robustness make SD0505D52U1 ideal for high-speed data port and high-frequency line (e.g., USB 2.0 & antenna line) applications, such as cellular phones and HD visual devices.

Features

- IEC61000-4-2 (ESD) ± 25 kV (Air), ± 20 kV (Contact)
- IEC61000-4-4 (EFT) 40 A (5 / 50 ns)
- Cable Discharge Event (CDE)
- Package Optimized for High Speed Line
- Ultra-small Package 1.6 mm \times 0.8 mm \times 0.6 mm
- Protects One Data, Control Line (Unidirectional)
- Low Capacitance 0.4 pF(Typical)
- Low Clamping Voltage
- Low Leakage Current
- High Temperature to Reflow Soldering Guaranteed: 260 $^{\circ}$ C / 10 sec
- Flammability Rating: UL 94 V-0
- Halogen Free and RoHS Compliant

Order Information

| Type | Package | Marking Code | Delivery Form | Delivery Quantity |
|-------------|---------|--------------|---------------|-------------------|
| SD0505D52U1 | SOD523 | 5L | 7" T&R | 3000 PCS |

ESD Protection Diodes

Unidirectional ESD and Transient Voltage Protection

SD0505D52U1 SOD5233

Package Dimensions - SOD523

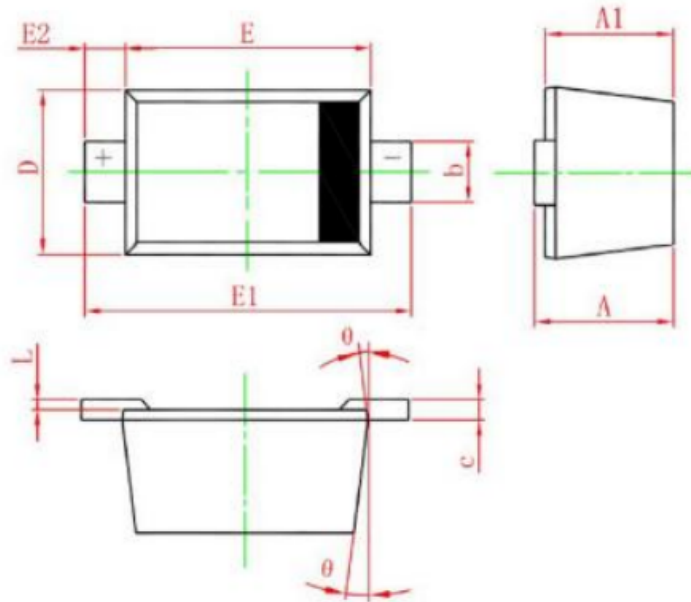

| Symbol | Millimeters | | Inches | |
|--------|-------------|------|-----------|-------|
| | Min. | Max. | Min. | Max. |
| A | 0.51 | 0.77 | 0.020 | 0.031 |
| A1 | 0.50 | 0.70 | 0.020 | 0.028 |
| b | 0.25 | 0.35 | 0.010 | 0.014 |
| c | 0.08 | 0.15 | 0.003 | 0.006 |
| D | 0.70 | 0.90 | 0.028 | 0.035 |
| E | 1.10 | 1.30 | 0.043 | 0.051 |
| E1 | 1.50 | 1.70 | 0.059 | 0.067 |
| E2 | 0.20 REF | | 0.008 REF | |
| L | 0.01 | 0.07 | 0.001 | 0.003 |
| φ | 7 ° REF | | 7 ° REF | |

ESD Protection Diodes

Unidirectional ESD and Transient Voltage Protection

SD0505D52U1 SOD52323

Limiting Values

(T_A = 25 °C, unless otherwise specified)

| Symbol | Parameter | Conditions | Min | Max | Unit |
|------------------|---------------------------------|--|-----|-----|------|
| V _{ESD} | Electrostatic Discharge Voltage | IEC 61000-4-2; Contact Discharge | - | 20 | kV |
| | | IEC 61000-4-2; Air Discharge | - | 25 | kV |
| I _{PP} | Peak Pulse Current | t _p =8 / 20 μs per IEC61000-4-5 | | 5 | A |
| T _A | Operating Temperature Range | - | -55 | 125 | °C |
| T _{stg} | Storage Temperature Range | - | -55 | 150 | °C |

Electrical Characteristics

(T_A = 25 °C, unless otherwise specified)

| Symbol | Parameter | Conditions | Min | Typ. | Max | Unit |
|------------------|-------------------------|---|-----|------|-----|------|
| V _{RWM} | Reverse Working Voltage | T _A = 25 °C | - | - | 5.0 | V |
| V _{BR} | Breakdown Voltage | I _R = 1 mA; T _A = 25 °C | 6.0 | - | - | V |
| I _R | Reverse Leakage Current | V _{RWM} = 5 V; T _A = 25 °C | - | - | 0.1 | μA |
| V _C | Clamping Voltage | I _{PP} =1 A, t _p =8 / 20 μs | - | - | 10 | V |
| | | I _{PP} =5 A, t _p =8 / 20 μs | - | - | 14 | V |
| C _J | Junction Capacitance | V _R = 0 V, f = 1 MHz | - | 0.4 | 0.5 | pF |

ESD Protection Diodes

Unidirectional ESD and Transient Voltage Protection

SD0505D52U1 SOD52323

Performance Curve for Reference

($T_A=25\text{ }^\circ\text{C}$ unless otherwise noted)

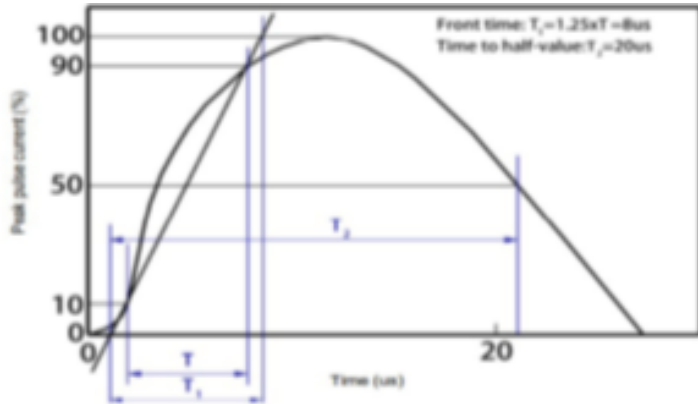

FIGURE 1

8 / 20 μs Waveform Per IEC61000-4-5

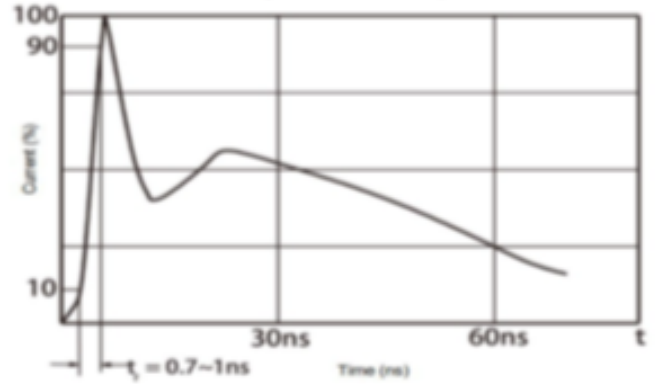

FIGURE 2

Contact Discharge Current Waveform Per IEC 61000-4-2

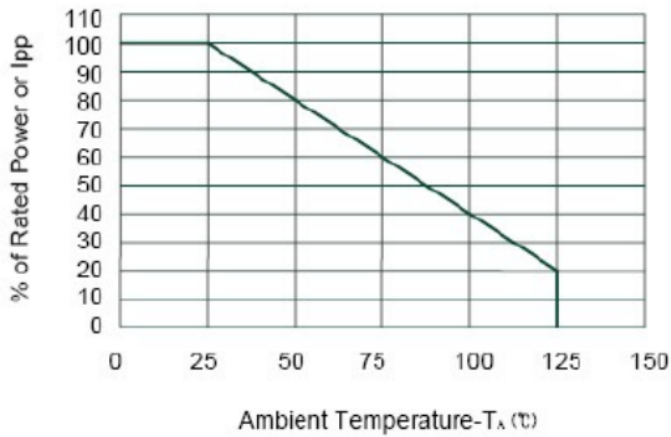

FIGURE 3

Power Derating Curve

ESD Protection Diodes

Unidirectional ESD and Transient Voltage Protection

SD0505D52U1 SOD52323

Soldering Parameters

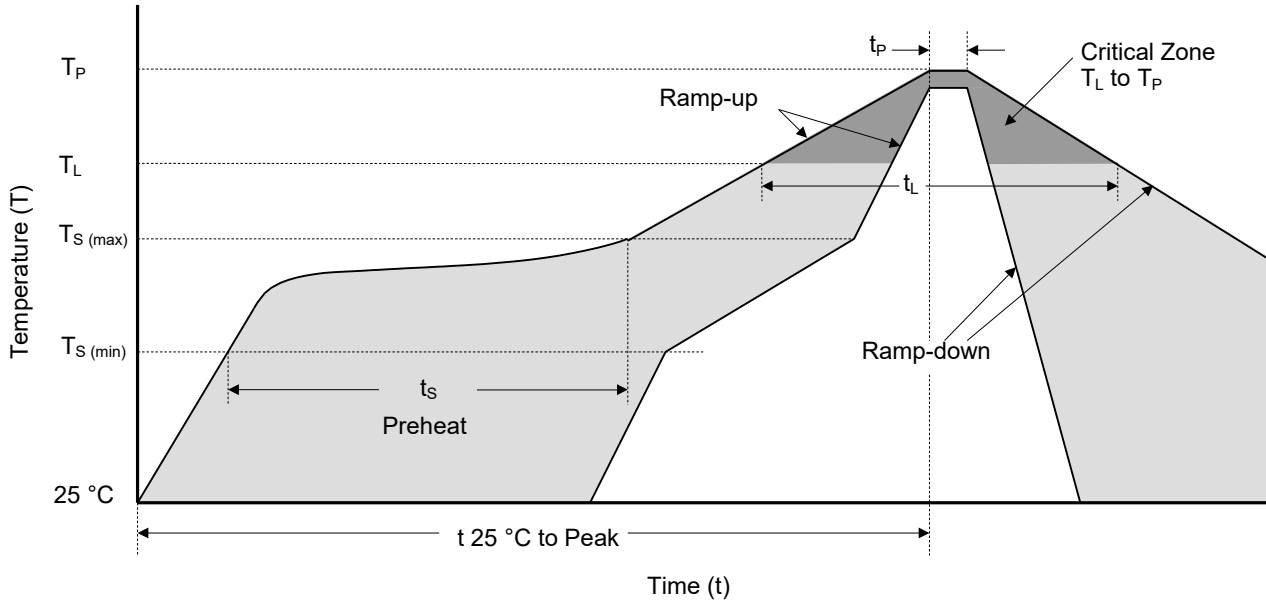

Reflowing Condition

| Reflow Soldering Parameters | | Lead-Free Assembly |
|--|-----------------------------------|-------------------------|
| Pre-heat | Temperature Min ($T_{S (min)}$) | 150 °C |
| | Temperature Max ($T_{S (max)}$) | 200 °C |
| | Time (min to max) (t_s) | 60 ~ 120 seconds |
| Average Ramp Up Rate (Liquidus Temp (T_L) to Peak) | | 3 °C / second max. |
| $T_{S (max)}$ to T_L Ramp-up Rate | | 3 °C / second max. |
| Reflow | Temperature (T_L) (Liquidus) | 217 °C |
| | Time (min to max) (t_L) | 60 ~ 150 seconds |
| Peak Temperature (T_P) | | 260 ^{+0/-5} °C |
| Time of within 5 °C of Actual Peak Temperature (t_p) | | 20 ~ 40 seconds |
| Ramp-down Rate | | 6 °C / second max. |
| Time from 25 °C to Peak Temperature | | 8 Minutes max. |
| Do Not Exceed | | 260 °C |



ATTENTION

Usage

1. TVS must be operated in the specified ambient temp.
2. Do not clean the TVS with strong polar solvent such as ketone, esters, benzene and halogenated hydrocarbon, to avoid damaging the encapsulating layer.
3. Please do not apply severe vibration, shock or pressure to TVS, to avoid element cracking.

Replacement

1. If TVS is visually damaged, please replace it.
2. TVS is a non-repairable product. For safety sake, please use equivalent TVS for replacement.

Storage

1. Storage Temp. Range: (-55 to 150) °C.
2. Do not store the TVS at the high temp., high humidity or corrosive gas environment, to avoid influencing the solder-ability of the lead wires. The product shall be used up within 1 year after receiving the goods.

Environmental Conditions











































1. TVS should not be exposed to the open air, nor direct sunshine.
2. TVS should avoid rain, water vapor or other condition of high temp. and high humidity.
3. TVS should avoid sand dust, salt mist, or other harmful gases.

Max. Typical Capacitance of TVS

The typical capacitance of TVS is listed in the specifications. Designers may refer to it when designing TVS in High frequency circuit.

Installation Mechanical Stress

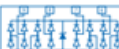
1. Do not knock TVS when installing, to avoid mechanical damage.
2. Please do not apply severe vibration, shock or pressure to TVS, to avoid surface resin or element cracking.

| Package Outline | | | | | Circuit Diagram | | | | | |
|---|---|---|---|---|---|---|---|---|---|---|
|  |  |  |  |  |  |  |  |  |  |  |
| DFN0603 | DFN1006 | DFN1006-3L | DFN1610 | DFN2020-3L | 1CH/UNI | 1CH/BI | 2CH/UNI | 2CH/BI | 1CH/BI | 1CH/UNI |
|  |  |  |  |  |  |  |  |  |  |  |
| DFN1610-6L | DFN2010-8L | DFN2510 | DFN2626-10L | DFN3810-9L | 1CH/UNI | 1CH/BI | 1CH/UNI | 1CH/BI | 2CH/UNI | 2CH/BI |
|  |  |  |  |  |  |  |  |  |  |  |
| SOD-923 | SOD-523 | SOD-323 | SOD-123 | SOT-143 | 1CH/UNI | 2CH/UNI | 2CH/UNI | 4CH/UNI | 5CH/UNI | 4CH/UNI |
|  |  |  |  |  |  |  |  |  |  |  |
| SOT-523 | SOT-323 | SOT-23 | SOT-363 | SOT-23-6L | 2CH/BI | 4CH/UNI | 4CH/UNI | 8CH/UNI | 8CH/UNI | 8CH/UNI |